

3 Gewindeschieber · Penstock · Tiroirs filetés
 nach DIN 19569-4 Dichtigkeitsklasse 4 · according DIN 19569-4 Class 4 · fabriqué du norme DIN 19569-4 classe 4

3.21 bxh = 500x500 - 1000x1000

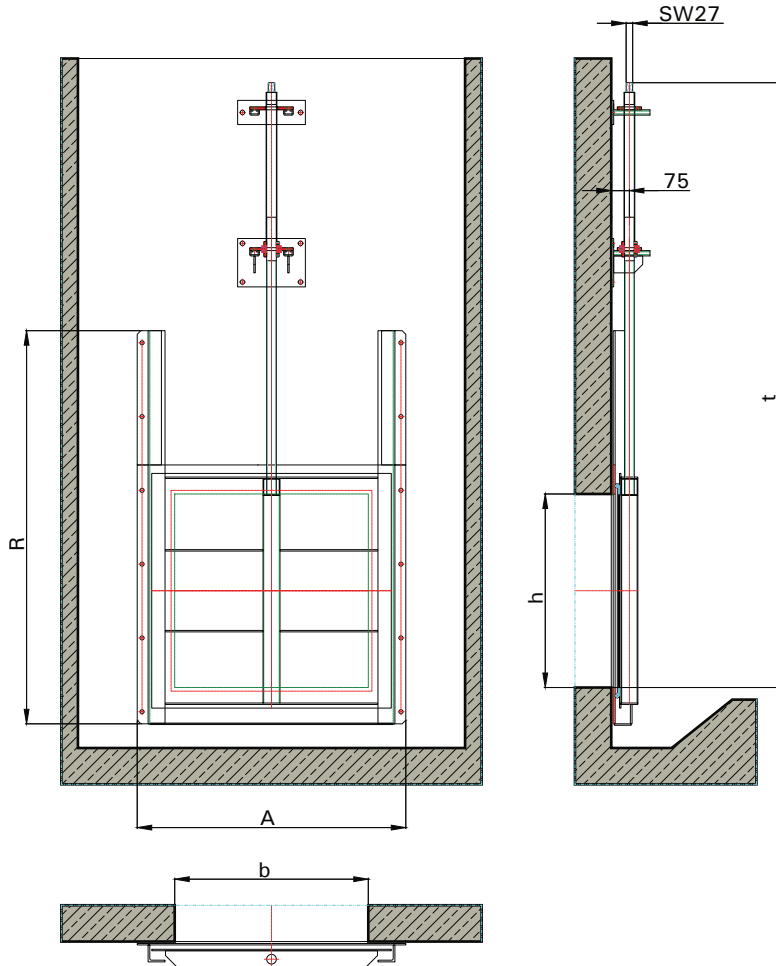

bxh	500	600	700	800	900	1000	
A	810	910	1010	1110	1210	1310	
R	1100	1275	1450	1625	1800	1975	
mk = Mindesteinbautiefe*	1500	1600	1900	2000	2300	2400	

*Minimum pipe depth Profondeur minimum d'installation

Werkstoffe Material Matériau

Rahmen Frame Cadre	ST 37	1.4301	1.4571	AlMg 3	HDPE	
Platte Plate Plaque	ST 37	1.4301	1.4571	AlMg 3	HDPE	
Spindel Spindle Broche	1.4104	auf Anfrage: 1.4305, 1.4571		on request/sur demande: s.s. 304, s.s. 306		
Bemerkungen Comment Remarques	Kunststoff HDPE und die Kombination der Werkstoffe auf Anfrage möglich plastic HDPE and material combination are available on request plastique HDPE et combinaison de matériau livrable sur demande					
Oberflächenbehandlung Coating Traitement de couche	Grundierung mit Icosit Aktivprimer 50 µm; jede andere Oberflächenbehandlung möglich undercoating with Icosit Aktivprimer 50 µm; -on request every coating is possible primaire avec Icosit Aktivprimer 50 µm; toute autre finition sur demande					
Dichtung Seal Composé	Plattengummi EPDM/APTK; -auf Anfrage: Viton, Teflon multi-fold profile rubber EPDM/APTK; -on request: Viton, Teflon caoutchouc en feuilles EPDM/APTK; -sur demande: Viton, Teflon					
Befestigungsmaterial Mounting parts Matériau de fixation	bei Ausführung zum Andübeln im Lieferumfang included in delivery for screw-on version compris dans la livraison pour modèle à goujonner					

3 Gewindeschieber · Penstock · Tiroirs filetés

nach DIN 19569-4 Dichtigkeitsklasse 4 · according DIN 19569-4 Class 4 · fabriqué du norme DIN 19569-4 classe 4

Bestellangaben/Aussparungen · Ordering informations/Openings · Données de commande/Évidements

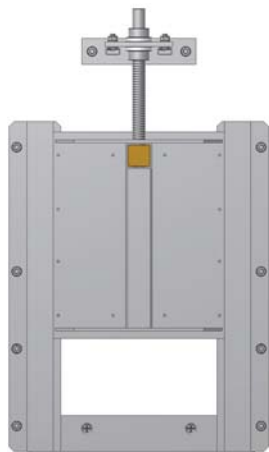

Variante Standard

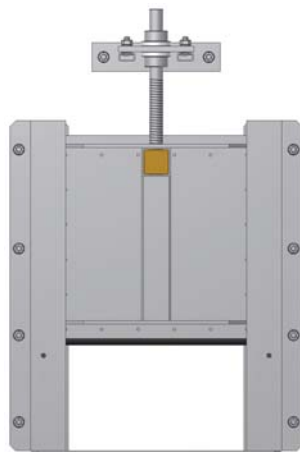

Variante NFG

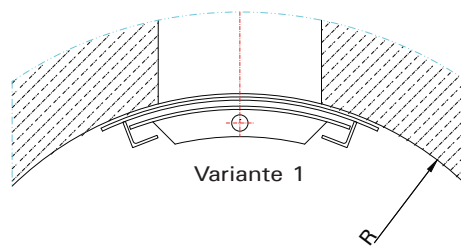
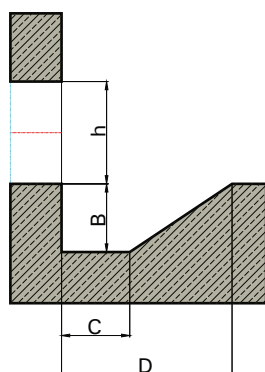
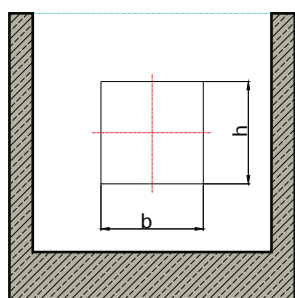

Variante 1

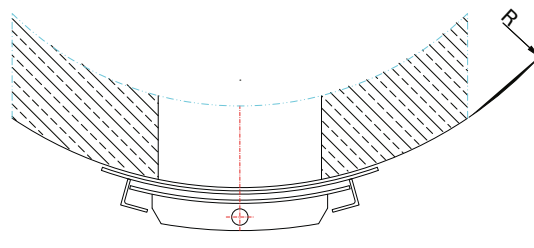

Variante 2

DN	B	C	D
100/100-450/450	200	200	500
500/500-1000/1000	250	250	500
1100/1100-1600/1600	400	400	800

Gewindeschieber BAP 3.	DN = mm
Penstock BAP 3.	k = mm
Tiroirs filetés BAP 3.	
Antrieb BAP	
Drive BAP	t = mm
Entraînement BAP	

Wasserdruck auf	PV = Vorderseite = bar	Pr = Rückseite = bar	
Water pressure on	PV = face = bar	Pr = back = bar	
Pression hydraulique de	PV = face avant = bar(s)	Pr = face arrière = bar(s)	
Werkstoff	Spindel =	Rahmen =	Platte =
Material	Spindle =	Frame =	Plate =
Matériau	Tige =	Cadre =	Plaque =